







36 607 985



- rosette 60 x 60 mm
- head part with cut-to-length spindle and sleeve

	Brushed Chrome	36 607 985-93
	Chrome	36 607 985-00
	Brushed Platinum	36 607 985-06
	Platinum	36 607 985-08
	Brushed Durabronze (23kt Gold)	36 607 985-28
	Brushed Dark Platinum	36 607 985-99

36 607 985

mm [inches]



Certificates

DVGW\_DW-  
6501DN0116.

WRAS\_2011026.

IAPMO\_4976 (2).

LGA\_29931.

WRAS\_2010066.

DVGW\_DW-  
6512DN0706.

LGA\_29932.

36 607 985

Parts for other finishes can be found here: [Chrome](#)

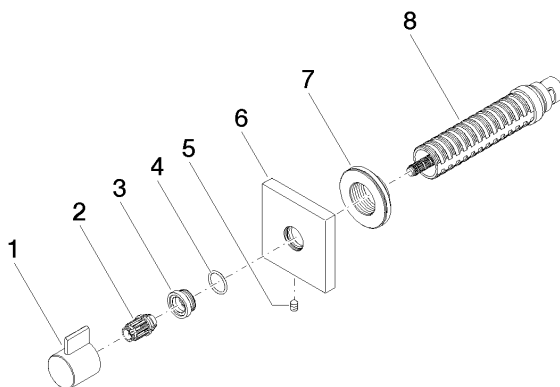

### Spare parts list

No.	Item Number	Name	Quantity used	Delivery time
1	09 20 98 002-93	handle	1	20
2	09 12 12 005 90	fixing cap	1	2
3	09 12 12 043-93	base	1	20
4	09 14 10 017 90	seal	1	2
5	90 31 11 004 00 90	pin	1	2
6	09 27 98 014-93	rosette	1	20
7	09 21 02 151 90	sleeve	1	2
8	90 90 03 202 00 90	top	1	2